

Coloring Book 3

K1 K2 K3 & EMH

Parents:

Teacher:

Student:

Date:



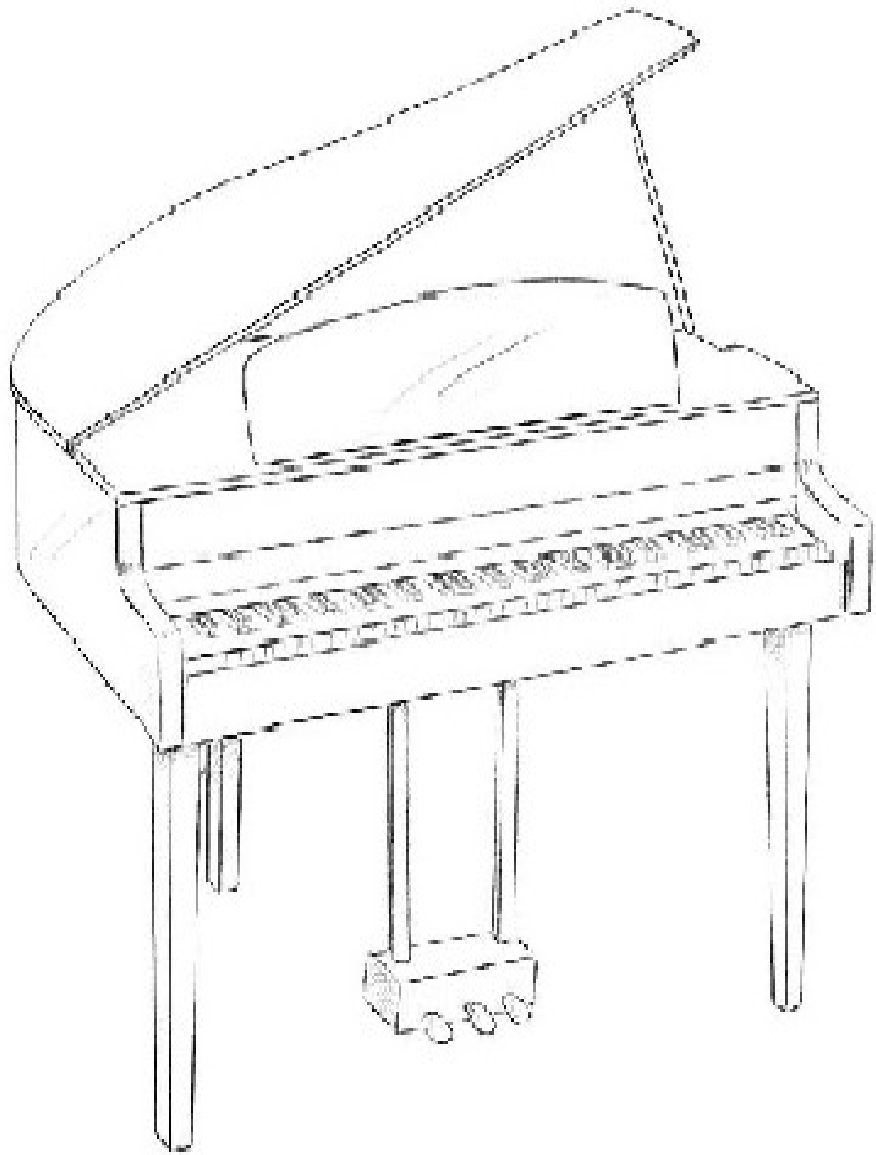

Piano

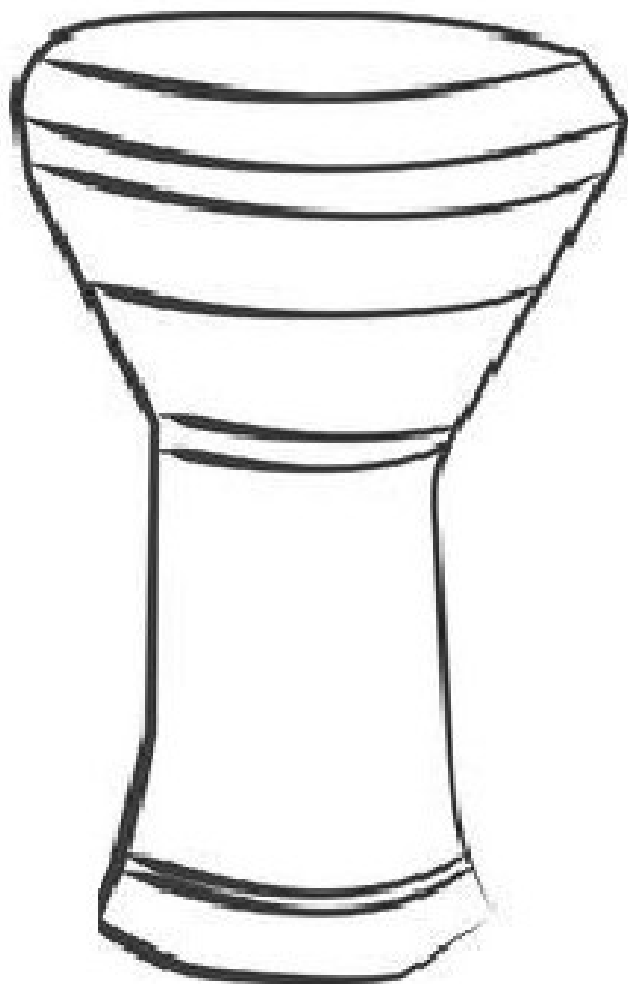

Darabuka

Clarinet





Guitar

Accordion

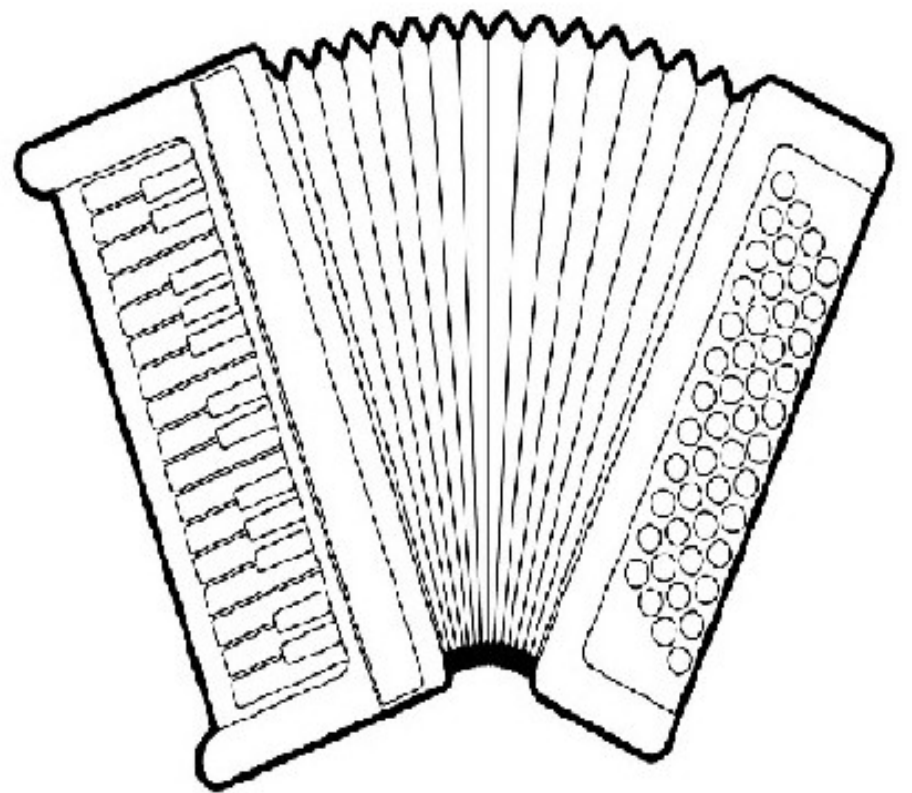

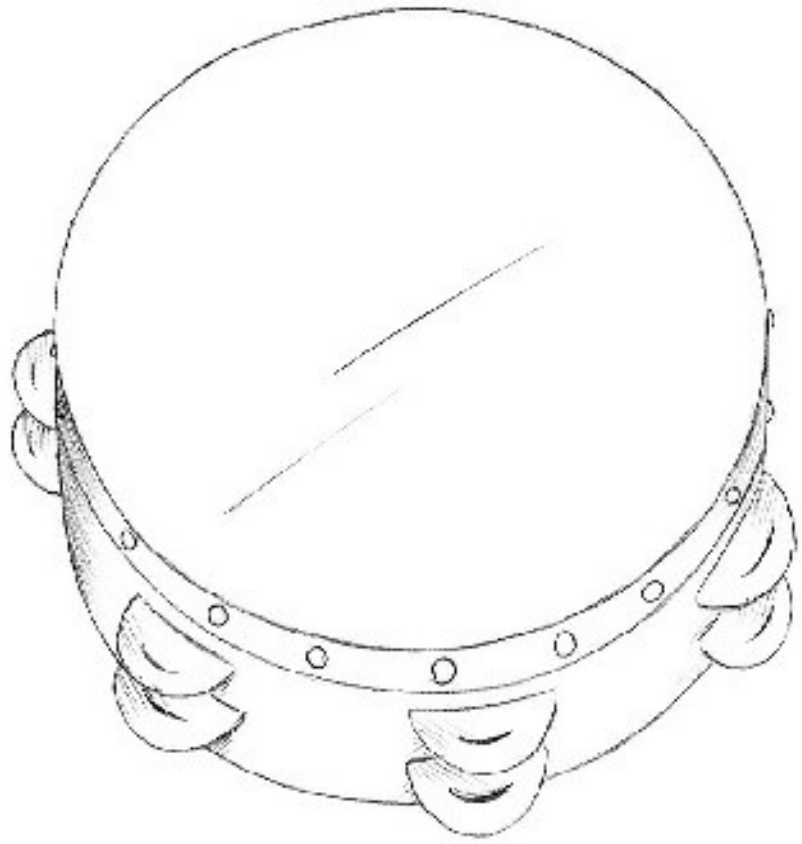

Tambourine

Maraca



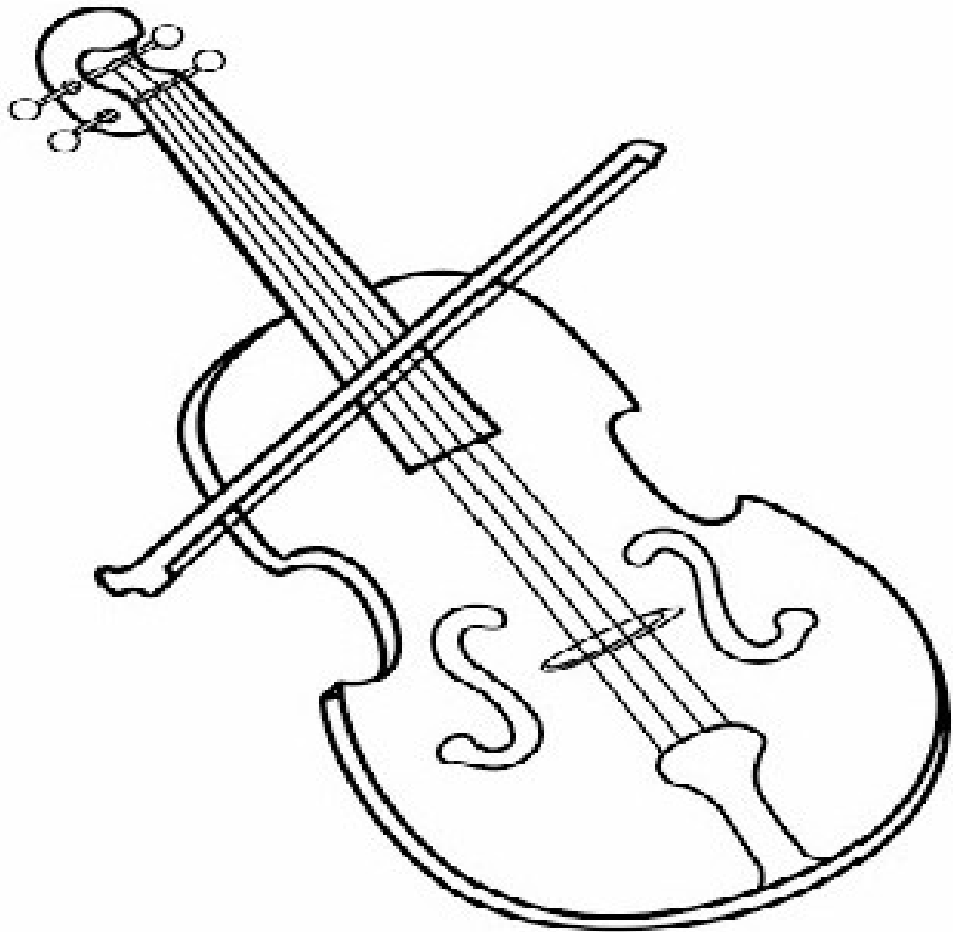

Violin

Triangle

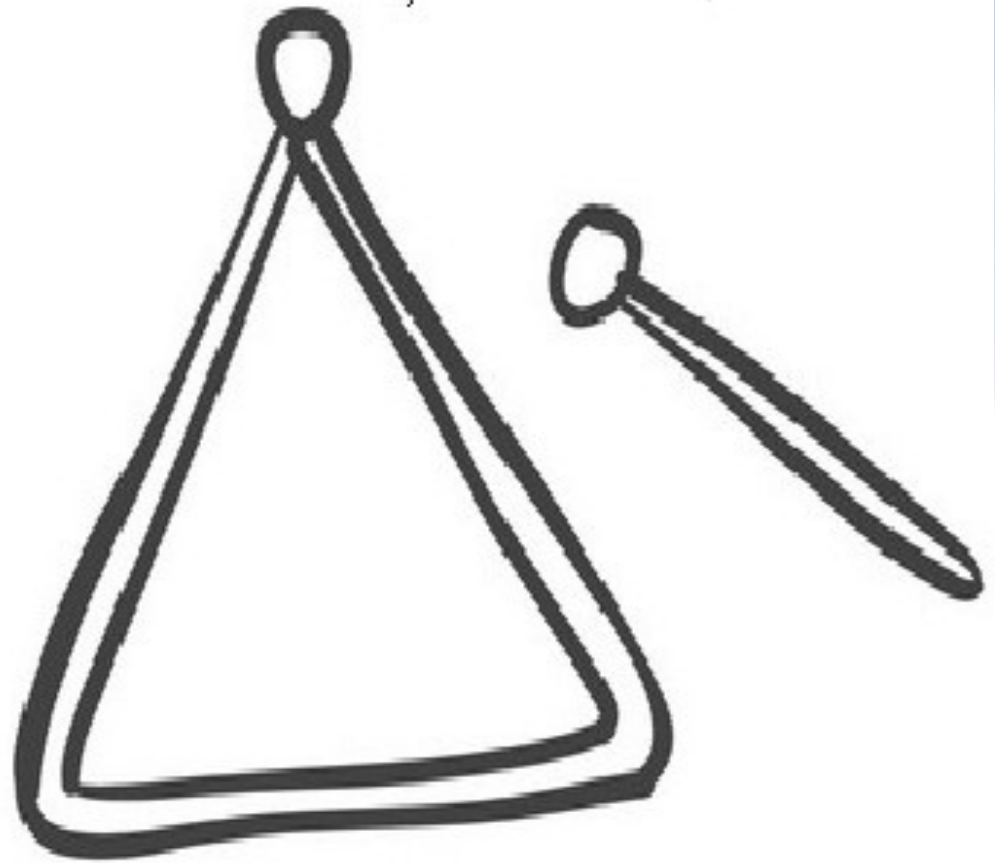



Trumpet

Snare Drum



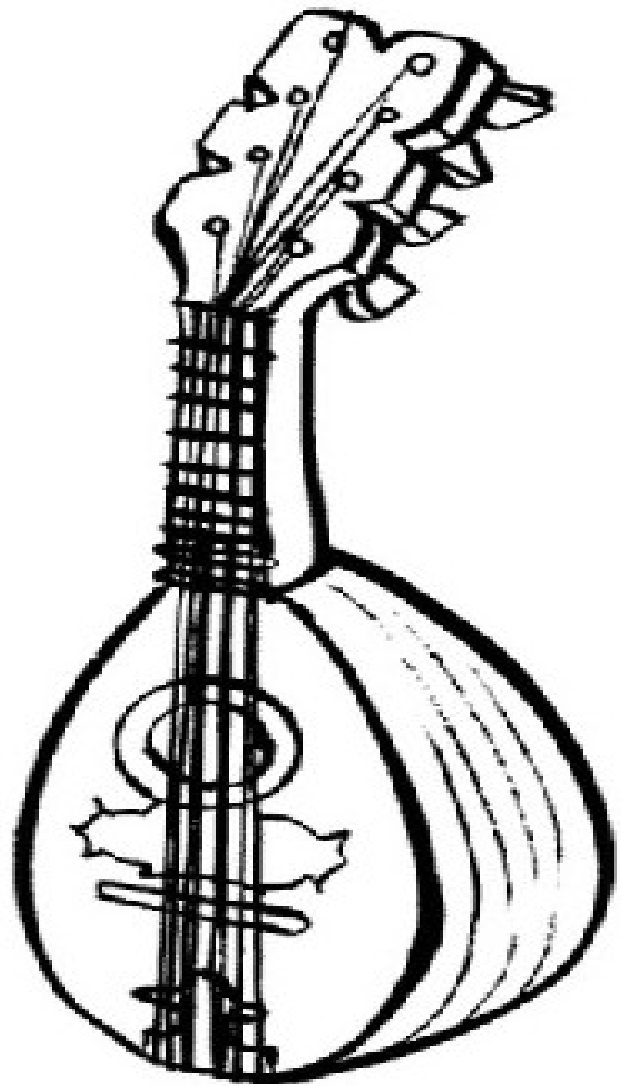

Mandolin

Sleigh Bells Instrument

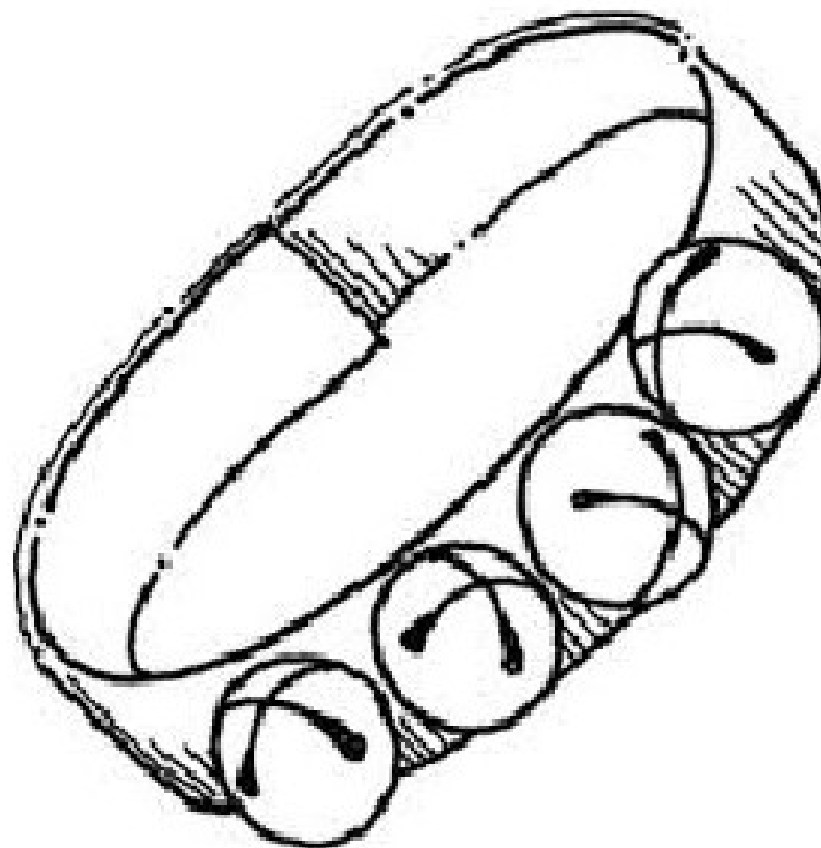

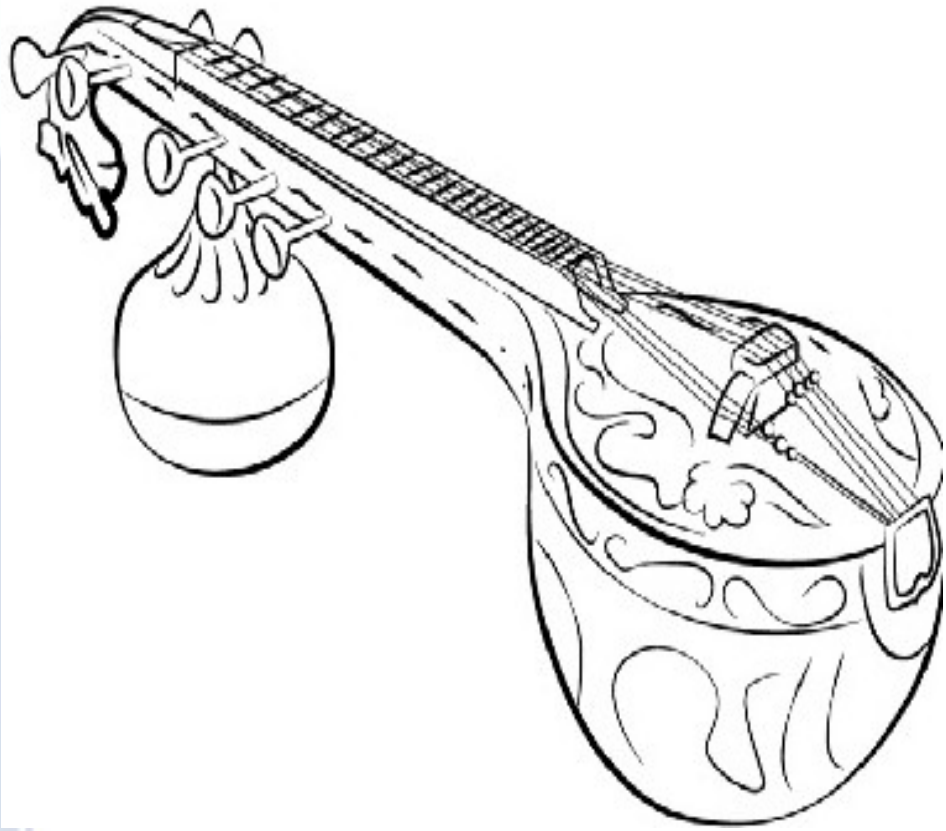

Banjo

Castanet

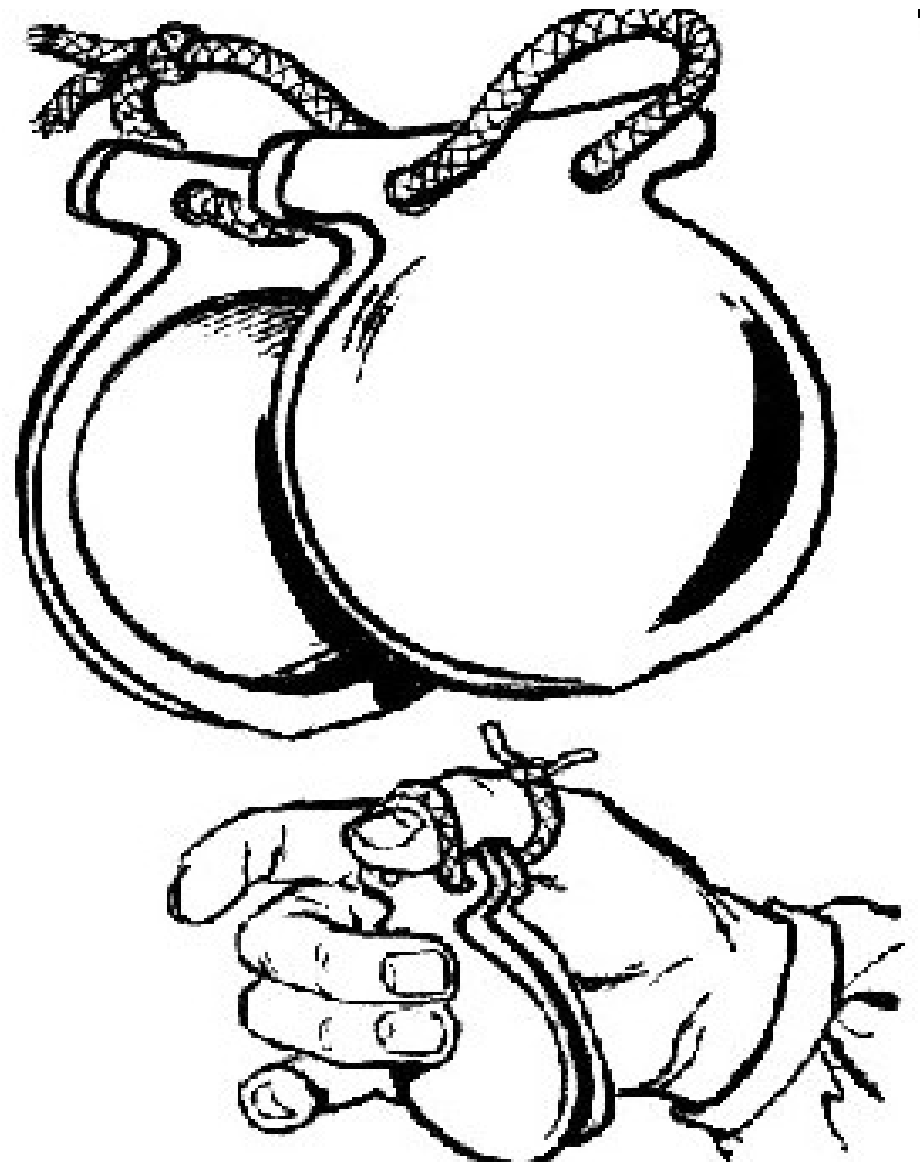

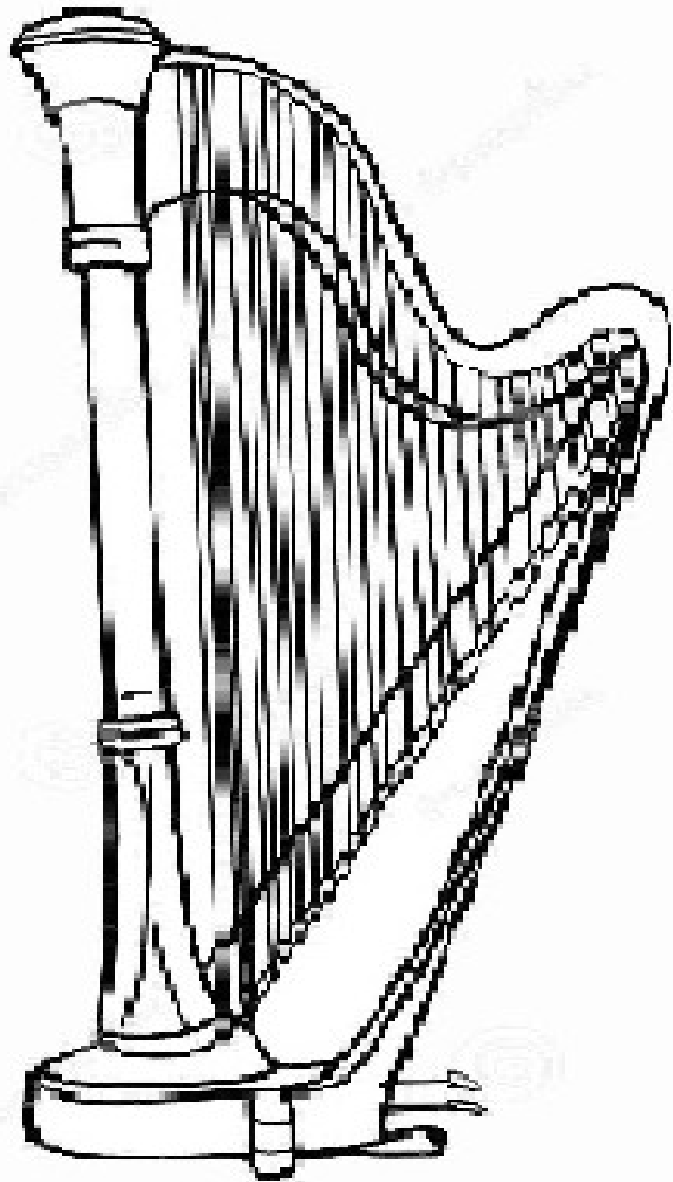

Harp

French Horn

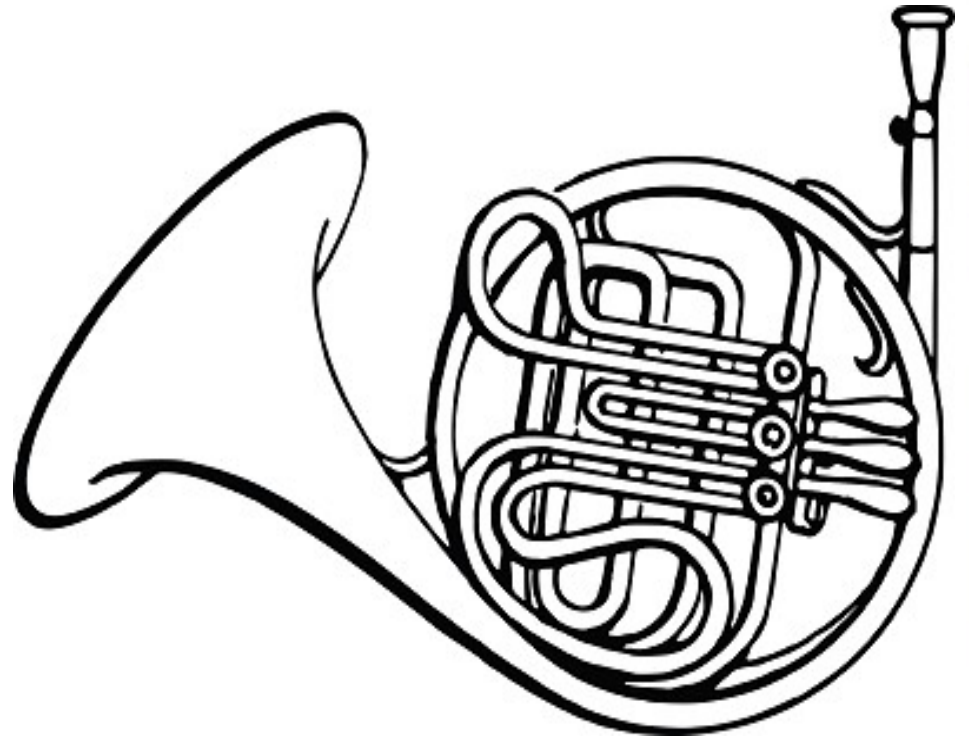

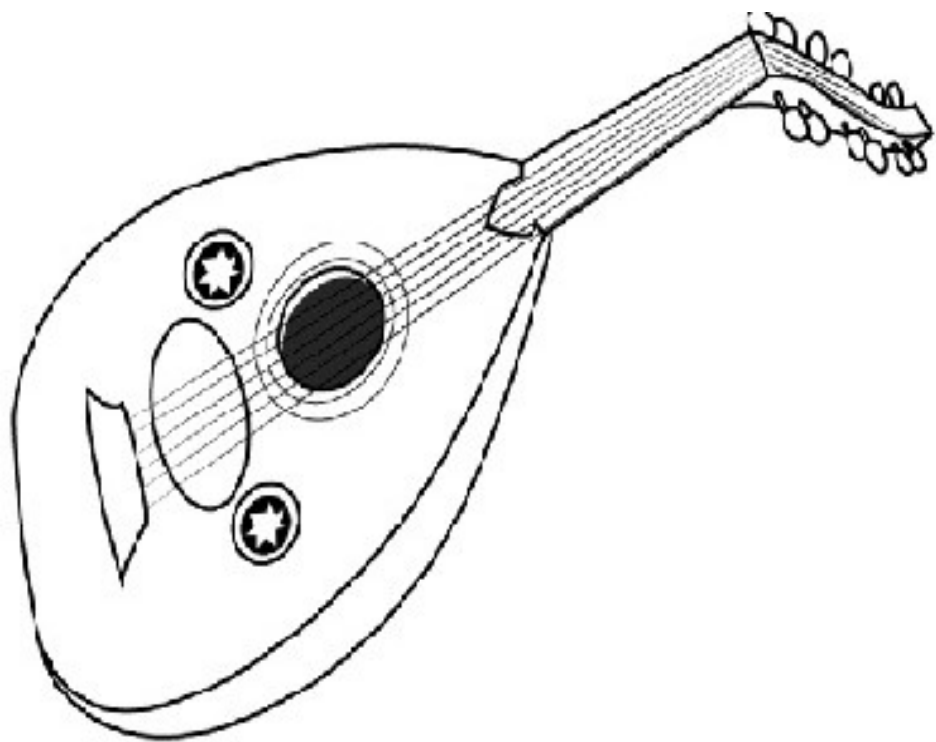

Lute

Harmonica

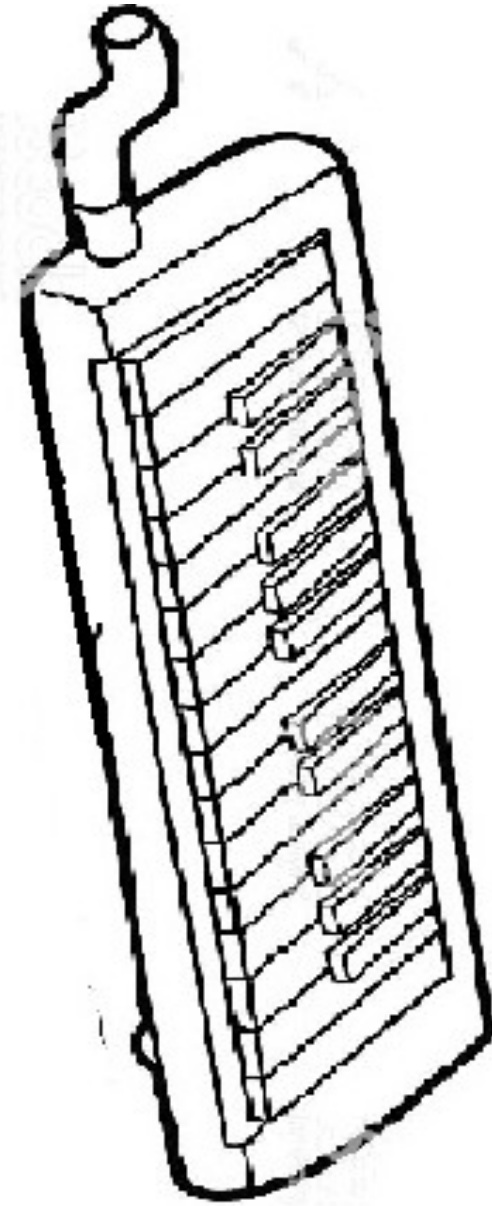



Cello

Xylophone

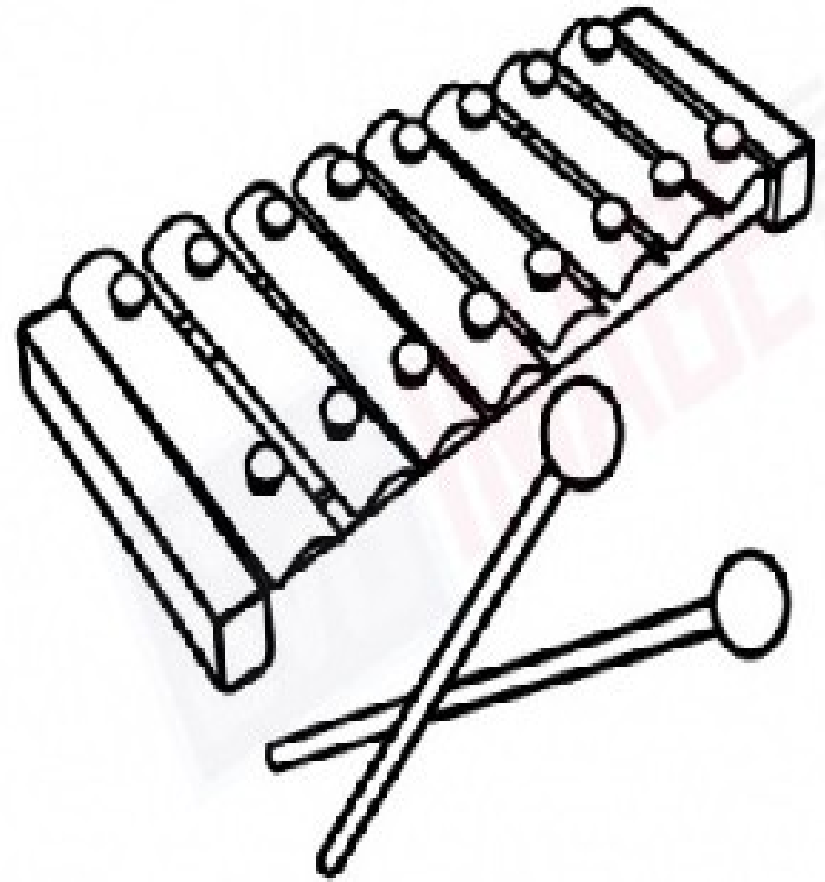



Drums

Saxophone

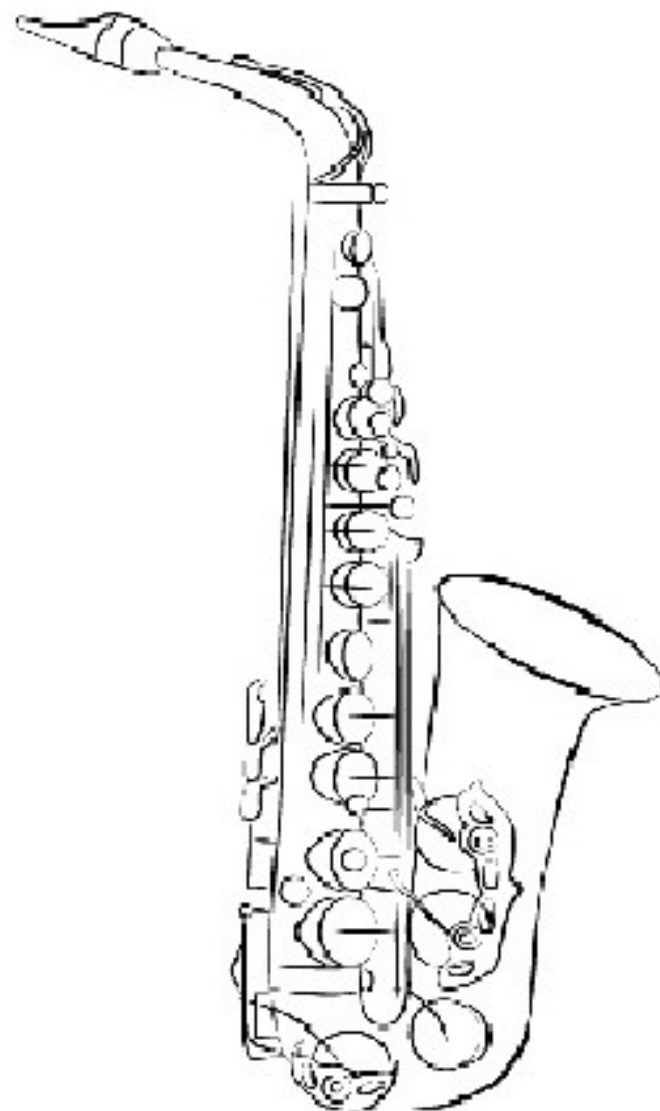

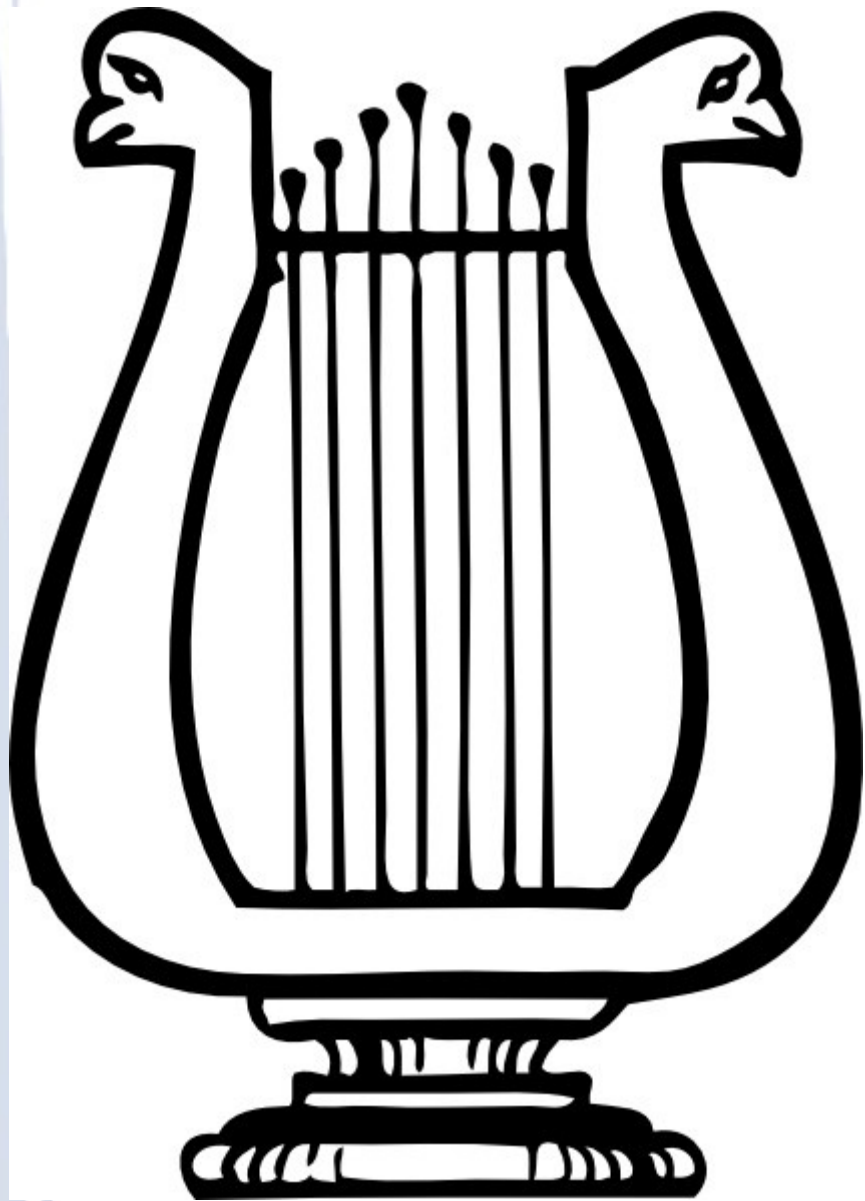

Lyre

Bongo Drums

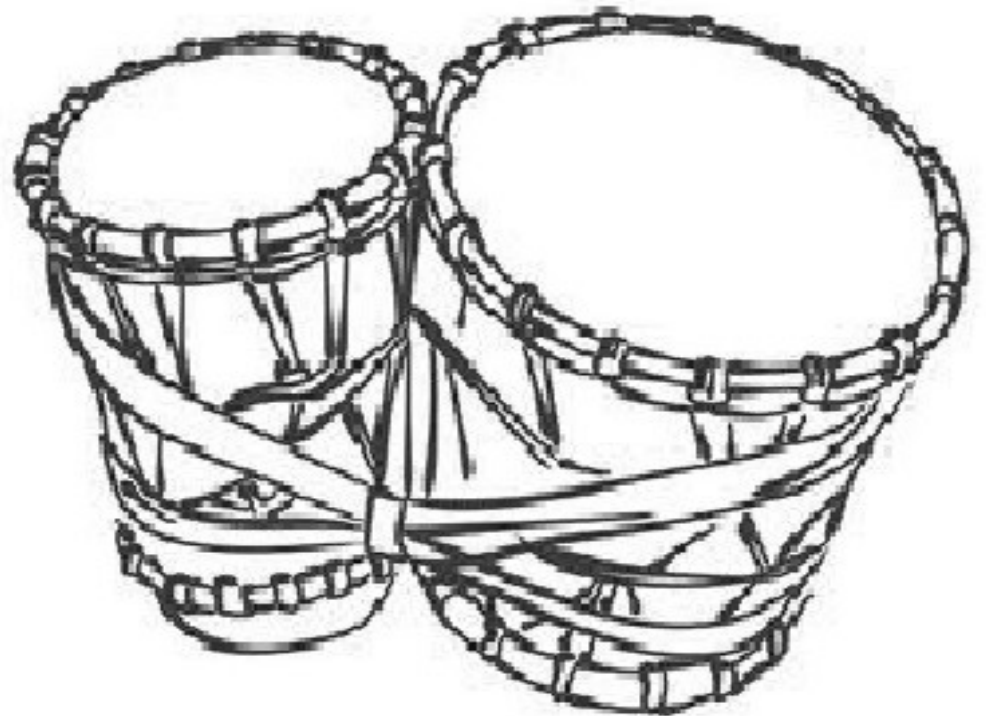

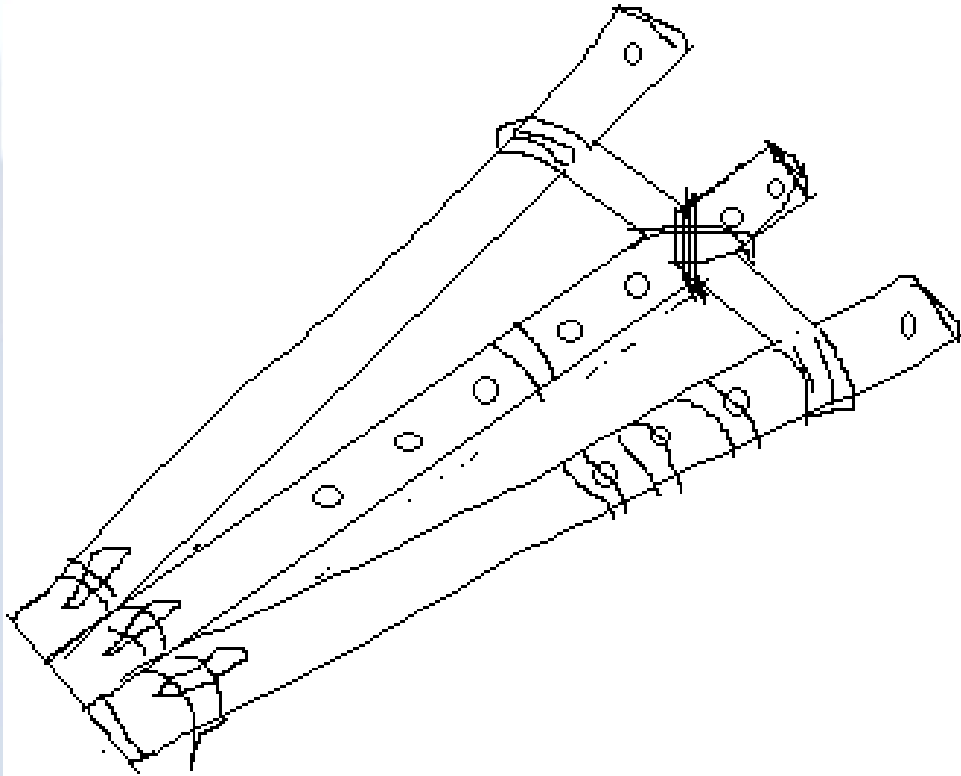

Triple Flute



Clarinet

Congas

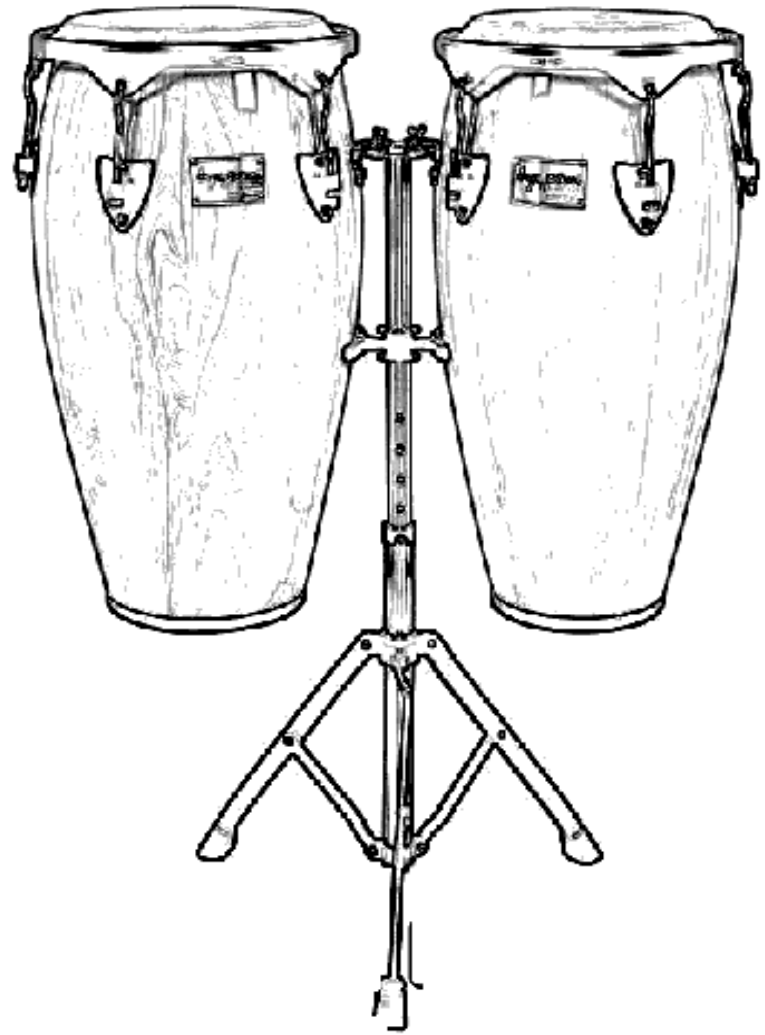



Qanun